

FRONT

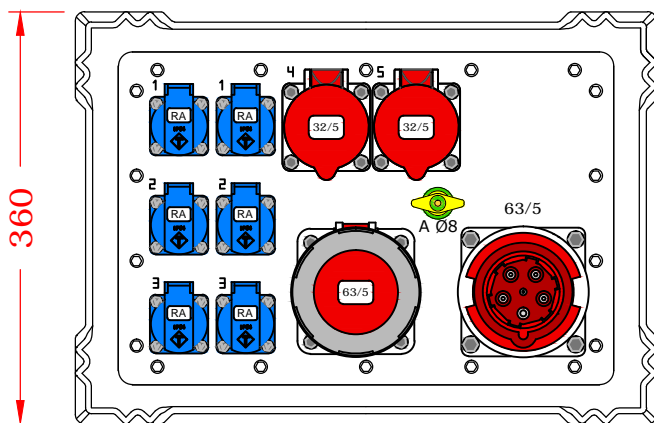

BACK

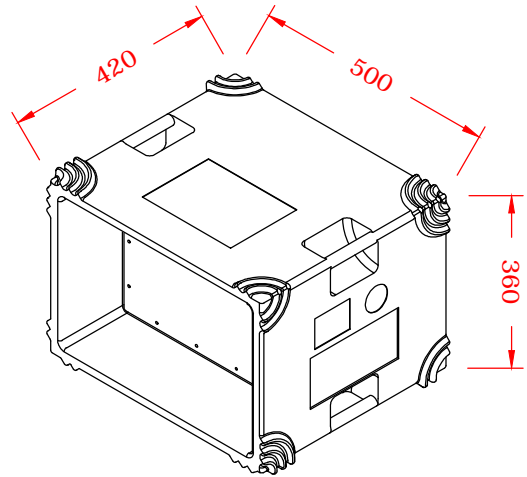
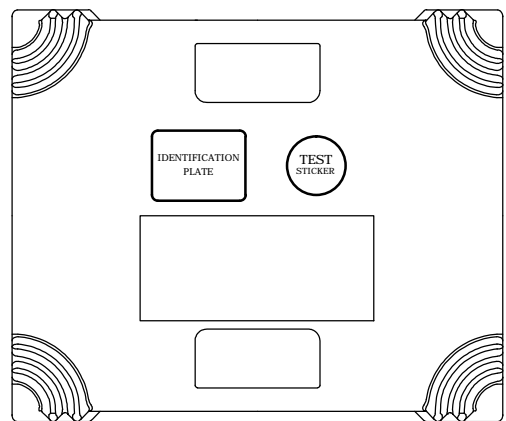

RIGHT



Vello Elektro BV
 Typograaf 14
 6921 VB Duiven NL
 +31(0)316 251500

Project:

V45.36.0552-D

A4

				Date	Name	Material: PE	Frame: N.V.T	Page 1
				23.05.2017	EP	Type: V45		
				Check		V45.36 63A		Of 1
				Adjustment				
NR.	Modified	Date	Name	Measurements in mm		Scale 1:6	Weight ca. 20 Kg	